

Compact, High Purity Reverse Osmosis

Undersink 3 Stage System with 'Twist-Off' Filter Cartridges



Compact High Purity Reverse Osmosis

Undersink 3 Stage System with 'Quick-Change' Filter Cartridges

7. Once the hole has been drilled install the faucet as per Diagram 5. Be sure the faucet body, chrome plate, and the black rubber washer are placed above the sink. Install the black locating washer, the lock washer and nut underneath, then tighten firmly while aligning faucet in the desired direction. Install female Quick Fit Connector to the end of the faucet (see Diagram 5).

8. Place the storage tank in a convenient position. The tank can be placed either upright or on it's side. Attach the Storage Tank Tap, applying a few wraps of s tape.

⚠ Do not over tighten the tap when attaching to the tank thread. Over tightening may split the tap body.

9. Connect hosing to the system, please refer to Diagram 5. Make sure the end of the tube is cut straight, ensuring it has an even, clean surface. It is recommended to not shorten the tubes.

10. Activating the System for the first time - Ensure the storage tank tap and pure water faucet are turned off. Slowly turn the

cold water shut off valve until fully open and then check the system, plumbing assembly and all drain lines are secure and free from leaks.

If system is free from leakage, open the pure water faucet and wait until the tap starts dripping. When dripping occurs, open up the tank tap and close the pure water faucet. Wait a few hours for the pure water storage tank to fill (the time taken will depend on water pressure, temperature and tank size).

Open the Pure Water Faucet and let the water flow until all the air has been expelled from the system. Initially water may be slightly discoloured and have some aeration. This will take a few minutes. Close the pure water faucet. In 15 minutes, check the connections for leaks and correct if necessary.

ⓘ When away for extended periods of time, it is recommended to shut off the water supply (see Step 2).

Diagram 5 - Faucet Installation

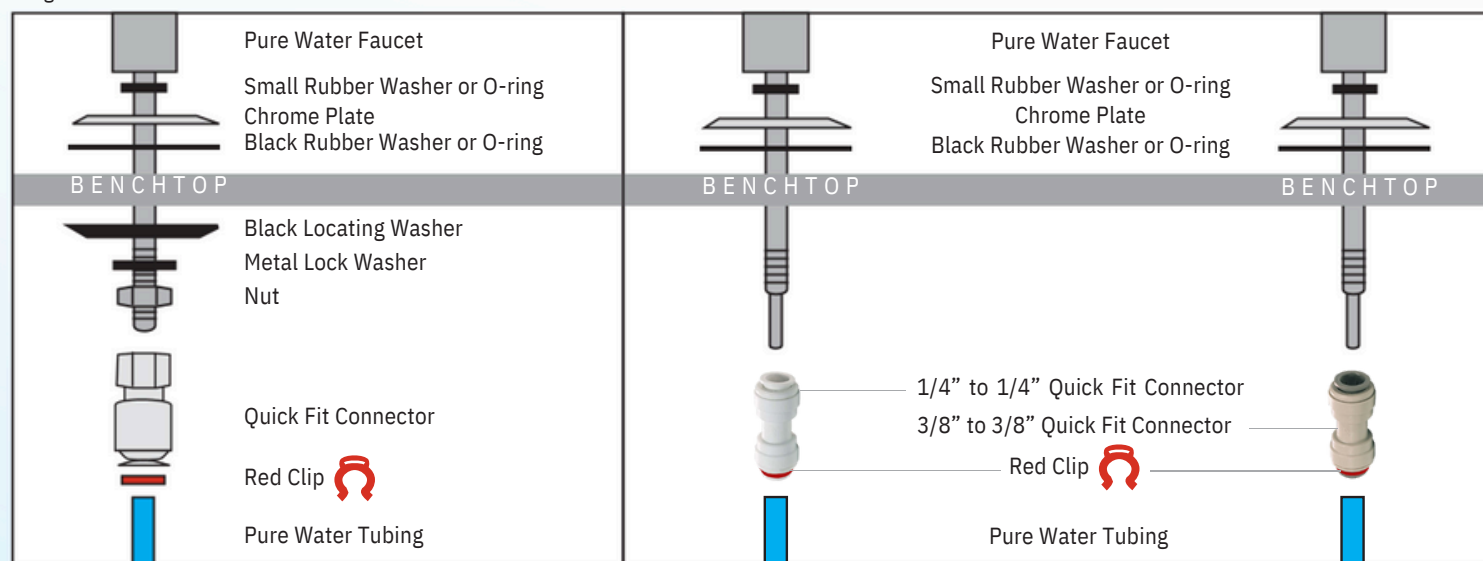
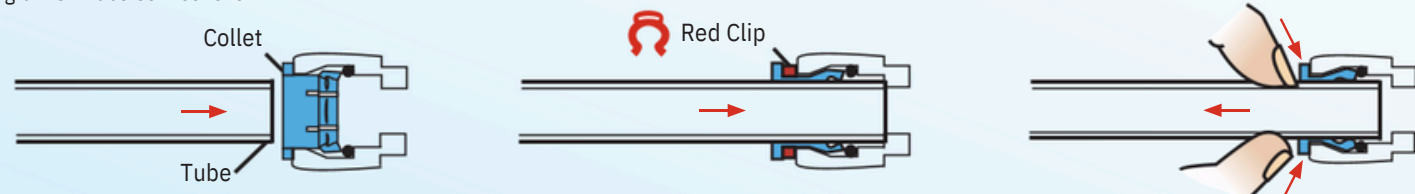

Diagram 6 - Tube Connections



1. To make the connection, push the tube firmly into the collet.

2. Make sure the tube is pushed as far as it can go and secure with a John Guest red clip.

3. To remove the tube - First remove the red clip. Use two fingers to push onto the collet and at the same time pull out the tube.

Handbuilt in Sydney with local, USA & UK components

Easy Maintenance with hygienic "Quick-Change" cartridges

5 Year Warranty* handbuilt & wet tested before sale

The Compact High Purity Reverse Osmosis water filter system has been especially designed where space under the kitchen sink is limited. Ideal for smaller kitchens and households. All this without sacrificing water quality or the production of the pure water. The space saving configuration will effectively remove unwanted contaminants of concern to health conscious consumers:- such as Chlorine, Chloramine, VOCs, Fluoride, Microbiological contaminants, Chemicals, Pesticides and Heavy Metals.

Impurities are flushed down the drain rather than collected in the filters.

This system includes a tank storing approximately 10 litres of pure water to dispense on demand.

DIY maintenance - easy to unscrew, hygienic cartridges make the annual maintenance of just one cartridge straightforward and economical!



Among the many contaminants removed:

Aluminium	Iron
Barium	Lead
Cadmium	Manganese
Chlorine	Mercury
Chromium	Nitrate
Copper	PCB's
Cryptosporidium	Potassium
e-Coli	Radium
Fluoride	Selenium
Giardia	Sodium
Hydrocarbons	Taste & Odour

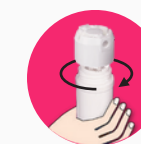

'Quick-Change' cartridges Ensures a simple, hygienic, no mess means of system maintenance.

Specifications

Item Code	IT007000
Output @60 Psi 25°C	approx. 300 litres p/day
Dimensions (cm)	30(W) x 18(H) x 17(D)
Micron Rating	0.0005 micron
Warranty	5 years*



Filtration Process Diagram 1

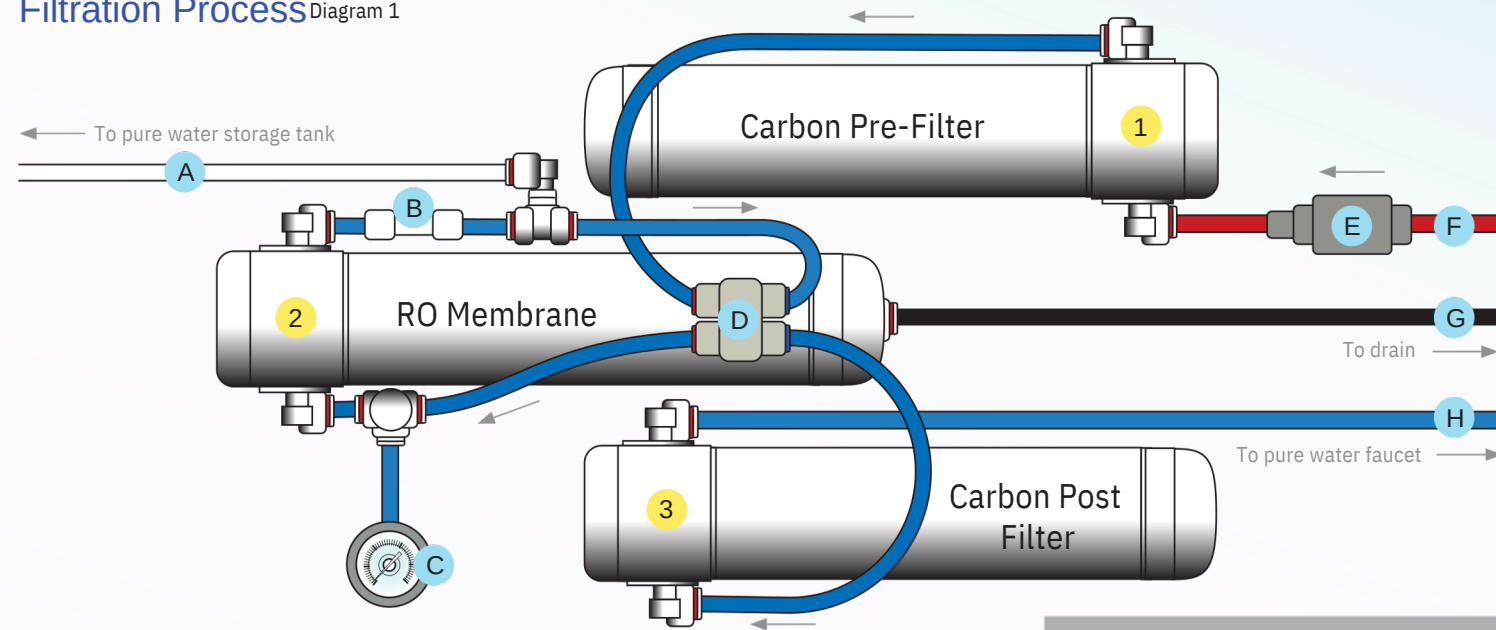

Labelled Components

- 1** Carbon Pre-Filter **Made in USA**
Removes chlorine, pesticides, heavy metals and other organic pollutants.
- Ultrafine TFC RO Membrane **Made in USA**
- 2** Screens to 0.0005 micron, filtering viruses, bacteria and parasites. Repels heavy metals and removes Fluoride and Hydrocarbons.
- Coconut Carbon Post-Filter **Made in USA**
- 3** Final polishing filter results in superb tasting, pure water.

- A** 1/4" White Tube **FOOD GRADE**
Feeds pure water to the pure water storage tank.
- B** Check Valve
Prevents backflow.
- C** Pressure Gauge
Indicates water pressure and condition of pre-filter.
- Automatic Shut-off Valve
- D** Automatically turns off feed water when tank is full.

- E** Pressure Limiting Valve (PLV)
Limits the pressure of incoming water.
- F** 1/4" Red Tube **FOOD GRADE**
Connects the feed water to the system inlet.
- G** 1/4" Black Tube **FOOD GRADE**
Feeds waste water to the drain.
- H** 1/4" Blue Tube **FOOD GRADE**
Feeds pure water to the pure water faucet.

How does it work?

Contaminated water is forced by mains water pressure through the semi-permeable membrane. Pure water molecules easily pass through the membrane while pollutants, typically larger than the membrane pore size (.0005 micron) cannot and are instead washed down the drain.

This system is conveniently installed under your sink with your choice of standard filter faucet, included at no extra cost

To view our complete range of faucets and mixers please refer to our Faucets Brochure.

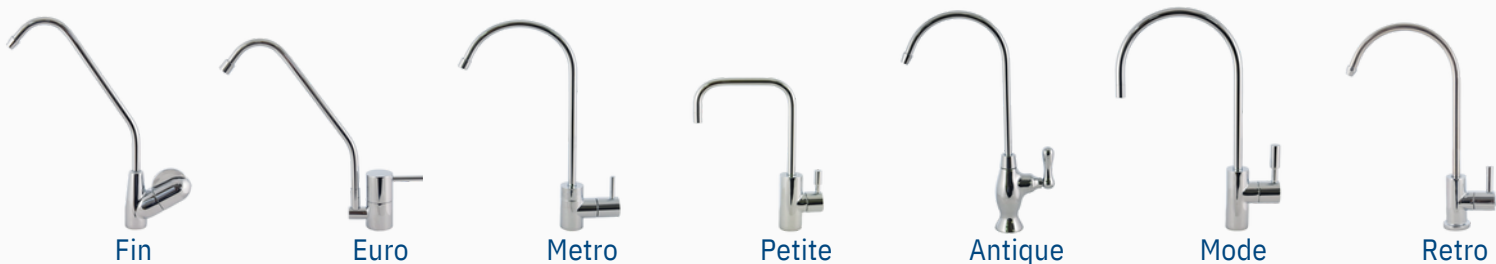

Step by Step Installation Instructions

1. Taking into consideration ease of maintenance, find a convenient location undersink. The system can sit freely on the cupboard base, or using the U-shaped clips - attach the filter to the cupboard wall.

2. Shut Off the Water Supply - Locate the ministop valve for the cold water feed line to your kitchen faucet/mixer (see Diagram 2).

Close the cold water shut off valve. Turn on the cold water only to assure that the line is completely shut off and drained. (If there is no cold water shut off valve located under the sink, then turn off the main water supply at the entry to the property).

⚠ Plumbing the system with hot water will damage the reverse osmosis unit.

3. Attach the Feed Water - Attach the feed water hose from ministop valve of the cold water line. Screw on the Female/Male Tee piece and re-attach braided hose to the male thread (see Diagram 3). Insert the provided 1/2m of 1/4" red tube into the quick connect fitting of the Female/Male Tee and secure with a red clip.

4. Installing the Leak Detector - Insert the two black washers within the female end of the Solenoid Shut Off Valve. Screw in the Quick Connect Male Fitting using plumbing tape as required. Attach the Quick Connect Female Fitting to the male thread of the Solenoid Shut Off Valve.

Connect the Solenoid Shut Off Valve to the 1/2" Female/Male Tee labelled E by inserting the 1/4" red tube into the Quick Connect Male Fitting and secure with a red clip. Connect the Solenoid Shut Off Valve to the system by attaching the system's 1/4" red tube labelled A (see Diagram 2 and 3) into the Quick Connect Female Fitting and secure with a red clip.

Place the Leak Detector at the lowest position possible close to your appliance/system. Ensure the metal contacts are face down, touching the area susceptible to water leakage. Note: If the surface where the unit is to be placed is made of metal - place a piece of paper or cloth between the unit and the surface.

5. Installing the Drain Outlet Clamp Assembly - Select a location for the drain clamp above the 'S' Trap.

Position the drain clamp on the drain pipe allowing adequate space for drilling. Tighten the clamp with the 'Tightening Screw' (see Diagram 4). Drill a 4mm hole through the drain clamp and into the PVC drain pipe. Clean debris from the clamp.

⚠ Where applicable, ensure you locate the drain connection away from any electric garbage disposal.

6. Pure Water Faucet Installation- The pure water faucet may be installed on any flat surface over 50mm (2") in diameter. First, check the underside of the location for interference (e.g. drawers, dishwasher). Make a small indent using a centre punch to mark the desired drilling location. Drill a pilot hole with a metal drill. Enlarge the hole using a 1/2" (13mm) metal drill bit.

Diagram 2 - Undersink Setup

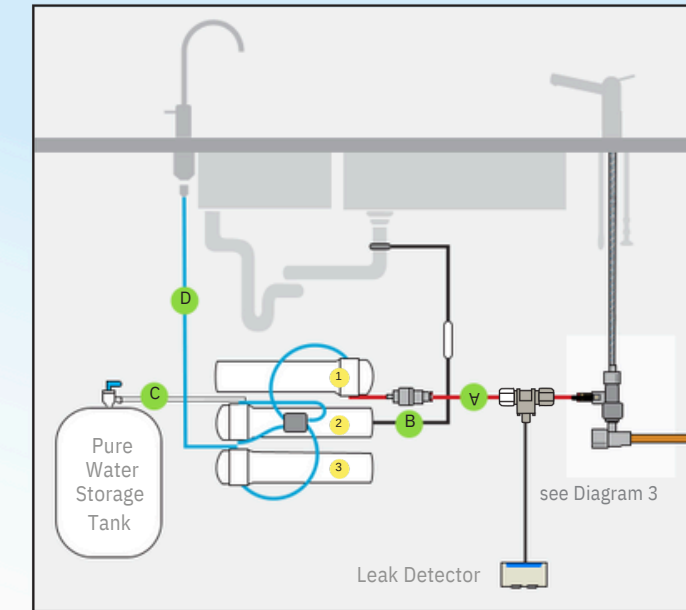

- A** Red tube connects the feed water valve to the system inlet
- B** Black tube connects the membrane port to the drain clamp
- C** Pressure Gauge connects the pure water outlet to the storage tank
- D** Blue tube connects the post filter to the pure water faucet

Diagram 3 - Tee Piece Assembly

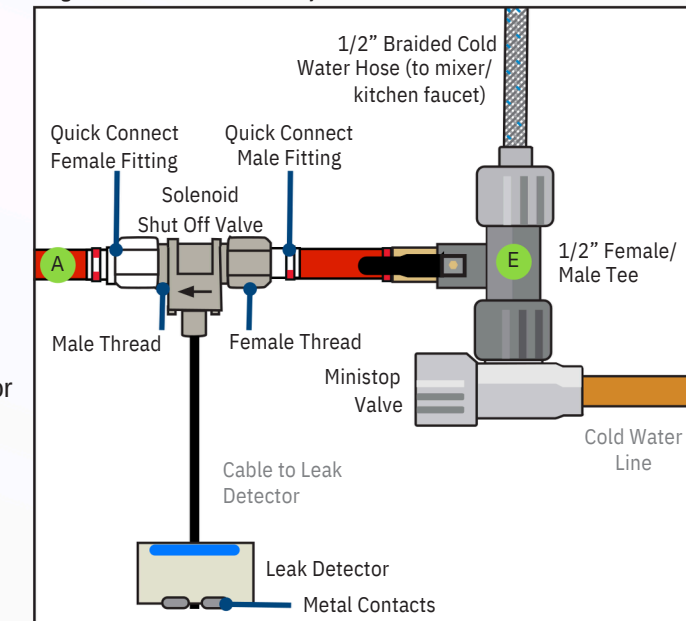

Diagram 4 - Drain Clamp

